

**Installation and operating instruction**

**Symondo Controller WLAN**



**Read carefully before installation, commissioning and operation**

# CONTENT

<b>Safety Instructions</b> .....	<b>3</b>
EG-Conformity .....	3
General Instructions .....	3
Changes to the Unit .....	3
Warranty and Liability .....	4
Disposal and Pollutants .....	4
<b>Description Symondo Controller WLAN</b> .....	<b>5</b>
Technical Data .....	5
Scope of Supply .....	5
<b>Installation</b> .....	<b>6</b>
Symondo Controller WLAN installation .....	6
Example Controller-Connection .....	8
Example CAN-Connection .....	8
<b>Operation</b> .....	<b>9</b>
Room Overview .....	9
Operating Mode .....	10
Menu .....	10
Set Operation Hours .....	11
Set Operation Hours .....	12
Expert Menu .....	13
Settings .....	13
Devices .....	14
Rooms .....	15
Sensors .....	16
Functions .....	17
WiFi .....	21
Access Point .....	22
WiFi Sensor .....	22
Service Values .....	23
Symondo Controller WLAN and Symondo App Configuration .....	23
Support .....	24
Notes .....	24

# SAFETY INSTRUCTIONS

## EG-Conformity

By affixing the CE mark to the unit the manufacturer declares that Symondo Controller WLAN conforms to the following relevant safety regulations:

- EU low voltage directive 2014/35/EU
- EU electromagnetic compatibility directive 2014/30/EU

conforms. Conformity has been verified and the corresponding documentation and the EU declaration of conformity are kept on file by the manufacturer.

## General Instructions

### Please read carefully!

These installation and operating instructions contain basic instructions and important information regarding safety, installation, commissioning, maintenance and the optimal use of the unit. Therefore these instructions must be read and understood completely by the installation

technician/specialist and by the system user before installation, commissioning and operation of the unit.

This unit is an automatic, electrical Symondo Controller WLAN. Install the unit only in dry areas and under the ambient conditions described in "Specifications".

In addition, observe the applicable accident prevention regulations, the regulations of the Association of Electrical Engineering, the local power supply utility, the applicable DIN-EN standards and the installation and operating instructions for the additional system components. Installation, electrical connection, commissioning and maintenance of the device may only be carried out by an appropriately trained specialist.

**Users: Make sure that the specialist gives you detailed information on the function and operation of the unit. Always keep these instructions in the vicinity of the unit.**

The manufacturer does not take over any liability for damage caused through improper usage or non-compliance of this manual!



Before working on the unit, switch off the power supply and secure it against being switched on again! Check that there is no power flowing! Electrical connections may only be made by a specialist and in compliance with the applicable regulations. The unit may not be put into operation if there is visible damage to the housing, e.g. cracks.

## Changes to the Unit

- Changes, additions to or conversion of the unit are not permitted without written permission from the manufacturer.
- It is likewise forbidden to install additional components that have not been tested together with the unit.
- If it becomes clear that safe operation of the unit is no longer possible, for example because of damage to the housing, turn the Unit off immediately.
- Any parts of the unit or accessories that are not in perfect condition must be exchanged immediately.
- Use only original spare parts and accessories from the manufacturer.
- Markings made on the unit at the factory must not be altered, removed or made illegible.
- Only the settings described in these instructions may be set using the Unit.



Changes to the unit can compromise the safety and function of the unit or the entire system.

## Warranty and Liability

---

The Unit has been manufactured and tested with regard to high quality and safety requirements. The warranty and liability shall not include, however, any injury to persons or material damage that is attributable to one or more of the following causes:

- Failure to observe these installation and operating instructions.
- Improper installation, commissioning, maintenance and operation.
- Improperly executed repairs.
- Unauthorised structural changes to the unit.
- Use of the device for other than its intended purpose.
- Operation above or below the limit values listed in the 'Specifications' section.
- Force majeure.

## Disposal and Pollutants

---

The unit conforms to the European RoHS 2011/65/EU for the restriction of the use of certain hazardous substances in electrical and electronic equipment.





Under no circumstances may the device be disposed of with the normal household waste. Dispose of the unit only at appropriate collection points or ship it back to the seller or manufacturer.

# DESCRIPTION SYMONDO CONTROLLER WLAN

## Technical Data



	Housing	2-part, ABS plastic 75 mm x 95 mm x 19 mm Glass front
	Display	Capacitive touch panel Color display with 240x320 dots 2.8 inches (7 cm) diagonal
	Operation	Intuitive user guidance
	Language	Deutsch            Italiano English            Français Español            Português

### Electrical specifications:

Power Supply	12 - 24 VDC +/- 10%
power consumption	max. 2,5 W
Protection Class	IP20
Protection class / overvoltage category	0/III

### Max. Cable Length

0-10V/PWM	<3m, if the cable length is >=3m it is necessary to use a shielded twisted pair bus cable and connect the shield on one side to the protective conductor.
1-Wire Bus	Optional, without function

### Permissible Ambient Conditions

during operation	0 °C - 50 °C, no moisture condensation permitted
for transport/storage	0 °C - 60 °C, no moisture condensation permitted

### Measurement Range

Outside the measuring ranges there are larger deviations	
Internal temperature sensor	0 °C - 60 °C            Accuracy +/- 1 °C Resolution 0,1 °C
Internal sensor for rel. humidity	0 % - 100 %            Accuracy +/- 6 °C Resolution 0,1 %
1-Wire temperature sensors	Optional, without function

 After switching on or disconnecting from the mains, it takes up to 60 minutes until the temperature is displayed precisely.

### Other Specifications

Installation Methods	Wall installation, with/without wall socket
Real Time Clock	RTC with 24 hour power reserve

## Scope of Supply

- Symondo Controller WLAN
- 2 screws 3,5 x 35 mm and 2 plugs 6 mm for wall installation.
- Symondo Controller WLAN installation guide

# INSTALLATION

## Symondo Controller WLAN installation

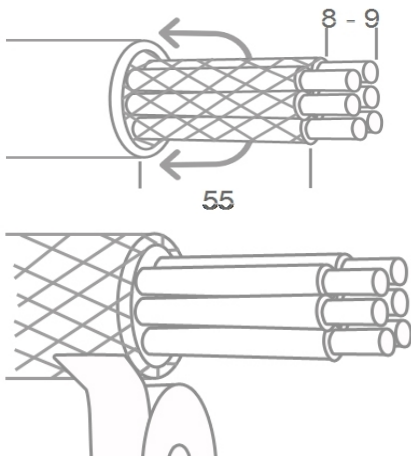
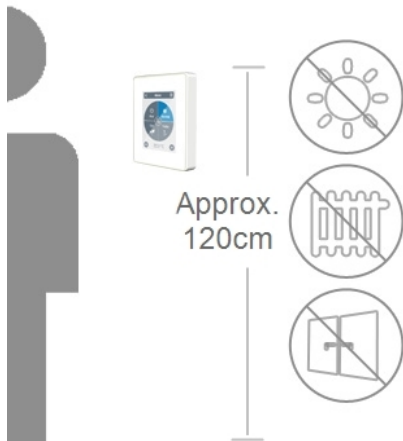

Mount the unit at a suitable location.



Pay attention to suitable environmental conditions. Direct sunlight, sources of heat and cold, e.g. radiators and windows must be avoided.

When wall mounting, make sure that the cables are kept as short as possible (max. 40 mm for direct wall mounting), as unnecessary vein loops in the Symondo Controller WLAN housing can lead to problems.

When mounting on a switch box, make sure that the cables are kept as short as possible (strip cables max. 55 mm) and that any vein loops are fed back into the switch box, as unnecessary vein loops in the Symondo Controller WLAN housing can lead to problems.

Strip the last 8 - 9 mm of the wires. Isolate shielding and connect it at a suitable location (controller or CAN-box) to the protective conductor.



Any contact between protective conductor and circuit board can cause serious damage.

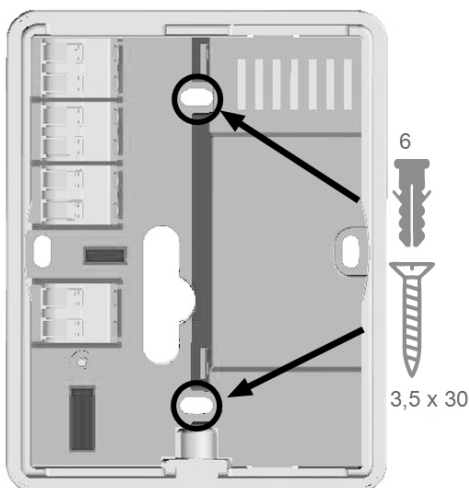

### Mounting on plastic wall socket

Fix the base with the screws (3,0 x 16) to the mounting box.

### Direct wall mounting

Hold the lower part of the housing up to the selected position and mark the three mounting holes. Make sure that the wall surface is as even as possible so that the housing does not become distorted when it is screwed on. Using a drill and drill holes at the points marked on the wall and push in the plugs. Insert screws and screw it in slightly. Align the base and tighten the screws.

Open the terminals with the accompanying operating tool and make the electrical connection as described.



Power supply 24 VDC, ensure correct polarity or it may cause damage to the unit!

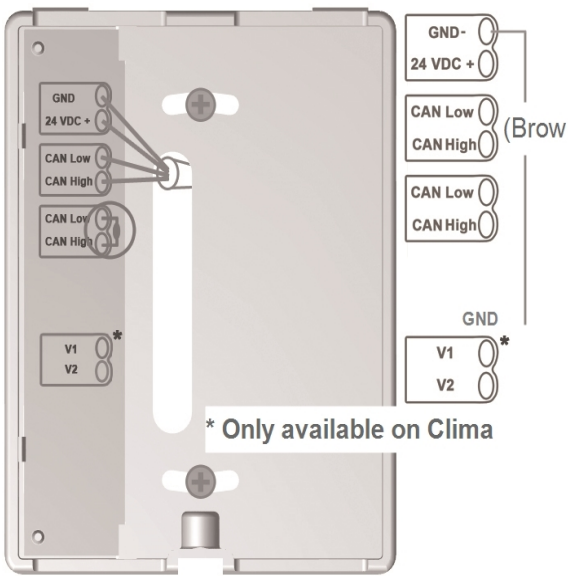

 The first and last unit in the CAN-network in series must be fitted with terminating resistance.



The connection of the opposite side (controller) can be found in the corresponding terminal diagram in the controller manual.

Refit the base and fasten with screw. Switch on the mains voltage and put Symondo Controller WLAN into operation.

 The setup wizard can be called up at any time in the Symondo Controller WLAN menu under Expert.

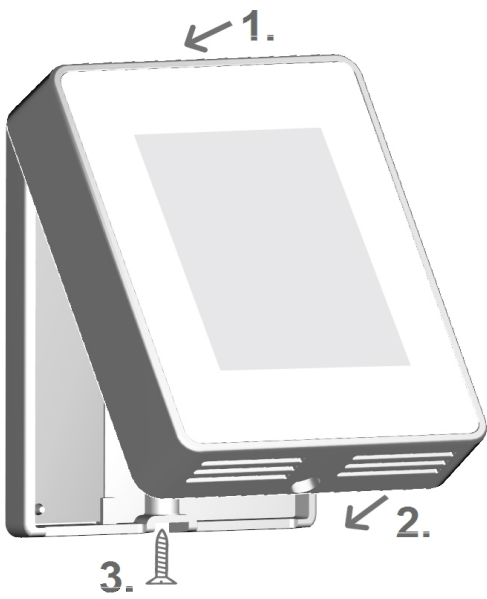

## Example Controller-Connection

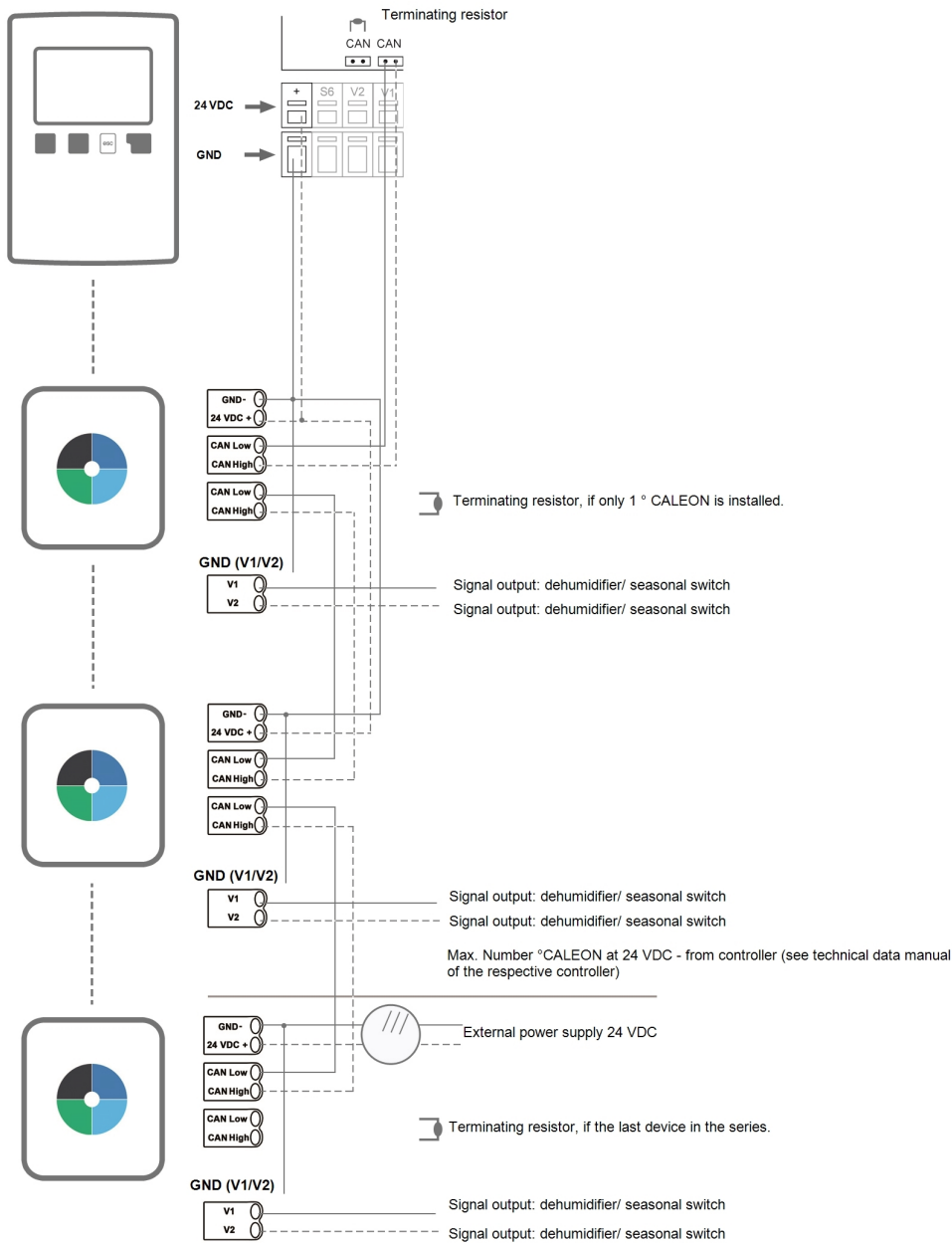

## Example CAN-Connection

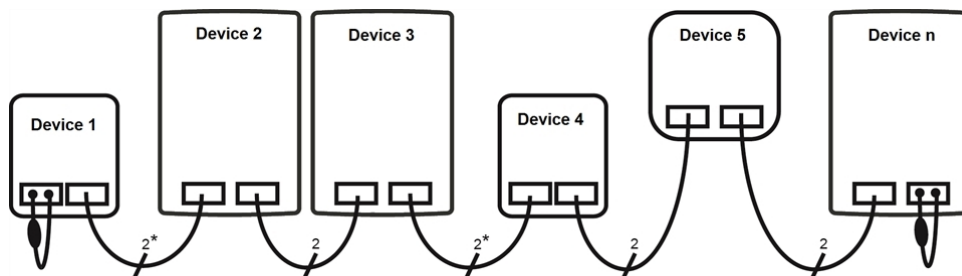

\*Only CAN in power supply from 4 cores of the regulator.

The order and the number of devices (max. 50) is arbitrary.

## Room Overview

Displays the room temperature, humidity and external temperature once the start screen was activated.



### Room icon

Selecting a room icon takes you to the room temperature settings.

### Multiroom selection

By dragging your finger vertically across several rooms, you can change the operating mode in all rooms at the same time.

### outdoor temperature

Displayed as soon as an outdoor sensor is used on the HCC or an outdoor sensor is activated on a Symondo Box in the menu "Expert > Symondo Box > Heating circuit > Sensor outdoor".

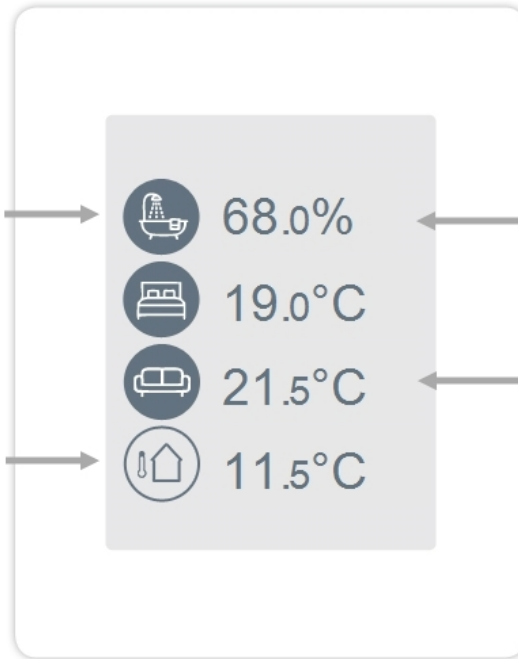

**%**

**Room humidity**

Relative humidity.

**°C**

**Room temperature**

Current room temperature.

# Operating Mode

Overview > Operating Mode



## Back/ Forward

Navigate back to the overview.



## Room

Displays the selected space.



## Reference temperature

Setting the reference temperature for the active operating mode in the displayed room.

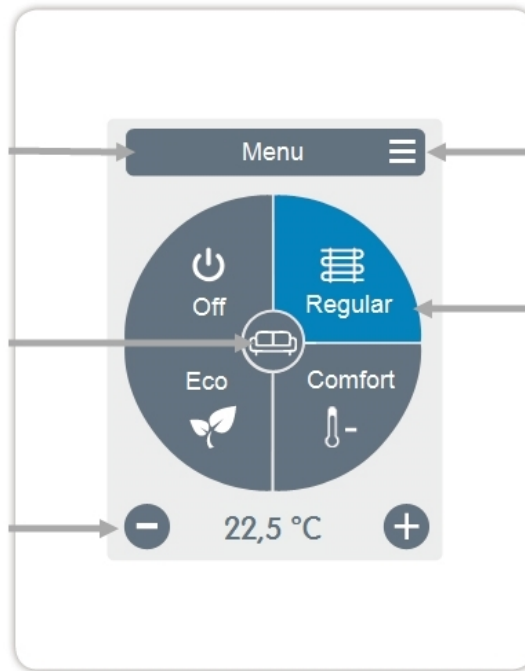

## Menu

Navigate to the main menu



## Operating Modes

The operating mode shown in colour is currently active and can be changed by selecting another mode. Manually selected modes remain active until the next change of mode by the timer program. A background frost protection function remains active in the "off" mode.

# Menu

Overview > Operating Mode > Menu



## Heating/cooling

Switch between heating and cooling modes.



## Holiday

Set the period and temperature for a longer absence.

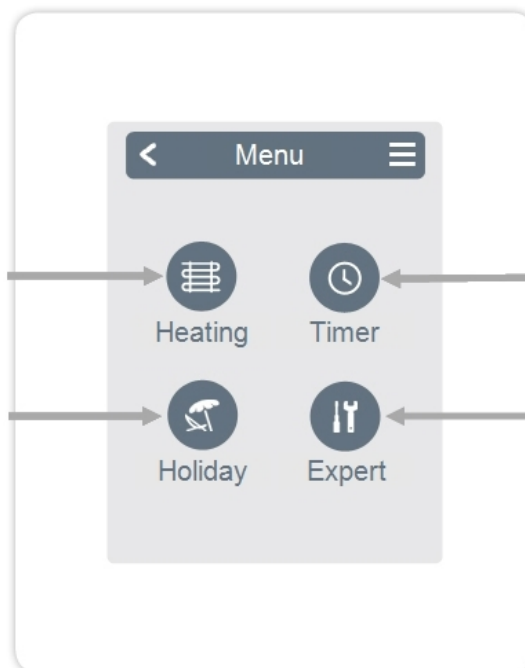

## Timer

Setting of individual heating or cooling times for each day of the week with copy function for subsequent days.



## Expert

Advanced settings for the technician.

# Set Operation Hours

Overview > Operating Mode > Menu > Timer

Setting of individual heating and cooling times for the selected room.

Separate times are set for the heating and cooling modes. To do this, first switch to the heating mode and define the corresponding times for this operating mode under Main menu > Timer. Then change to the cooling mode and define the corresponding times for this operating mode under Main menu > Timer.



### Operating Modes

Selection of the operating mode to select individual heating or cooling sections.

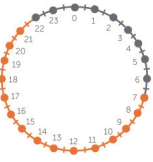

### Clock

Time table of the selection in periods of 30 minutes increments. Touch individual segments, or drag your finger over complete time intervals to colour them according to the selected operation mode.

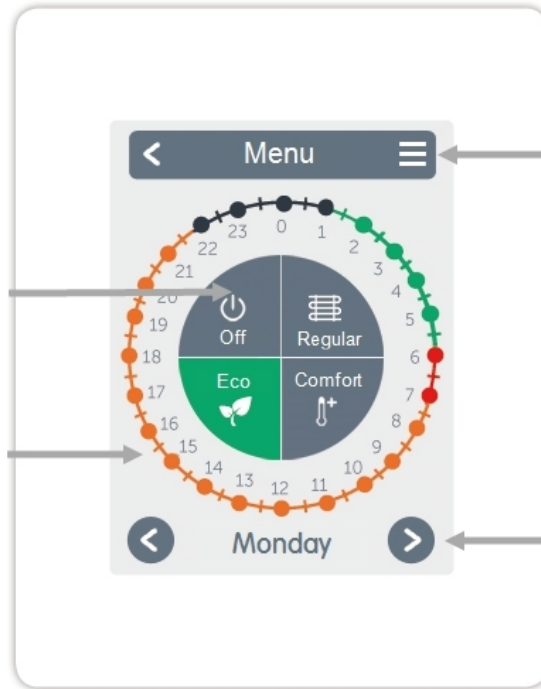

### Menu

Opens the copy function. The function allows you to copy the heating and cooling times to the following day, to Monday - Friday or to Monday - Sunday.



Monday



### Back / Next Weekday

Selects the set day.

## Set Operation Hours

### Step 1

Use the arrow keys to select the desired day.

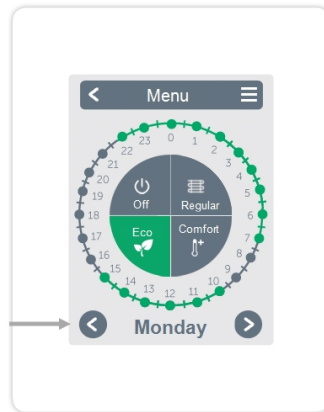

### Step 2

Select the first heating mode (Normal) - with the index finger select the desired length of time. The selected period will be coloured after selecting the colour of the operating mode (normal = orange). Set the times of the other operating modes in the same way.

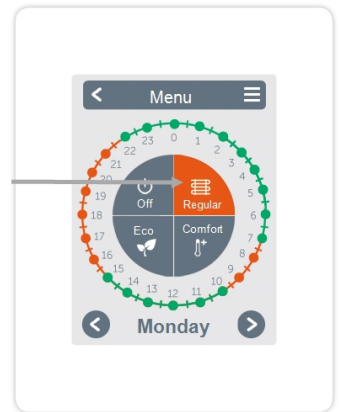

### Step 3

After completing the setting of the individual heating or cooling times, you have the option of copying the times via the main menu to the following day, to Monday - Friday or to Monday - Sunday or to set them individually for each day of the week.

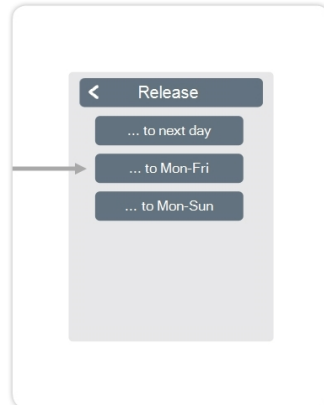

In the interests of efficient and energy-saving single room control, the operating times should be set specifically for each room.

# Expert Menu

Overview > Operating Mode > Menu > Expert

## Select Language

Set the device language.

## Settings

Parameterisation of heating/cooling system.

## Menu Lock

Activate menu lock to protect settings with a password.

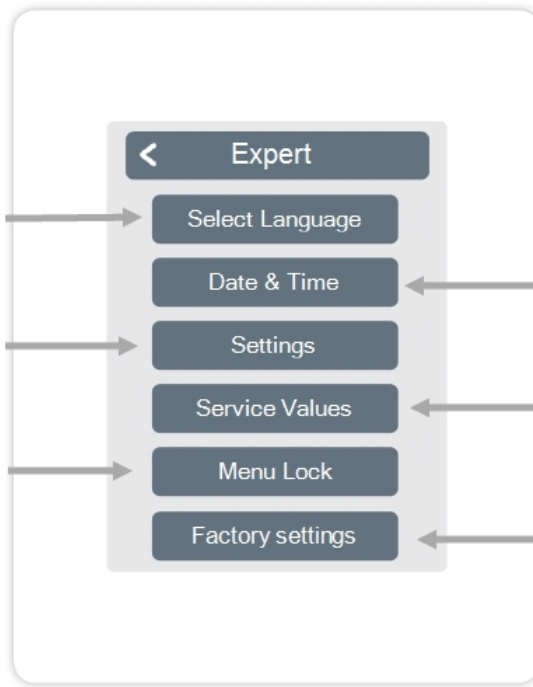

## Date & Time

Setting of time and date and automatic summer/winter time changeover.

## Service Values

Information about the system.

## Factory settings

The factory settings are restored in the device.

 The menu structure described here is based on the status at the time of production and may vary due to subsequent software changes.

# Settings

Overview > Operating Mode > Menu > Expert > Settings

## Devices

Add, manage and remove connected devices

## Symondo Controller

Assignment and configuration of additional functions for free switching outputs.

## Display Brightness

Adjust the screen brightness.

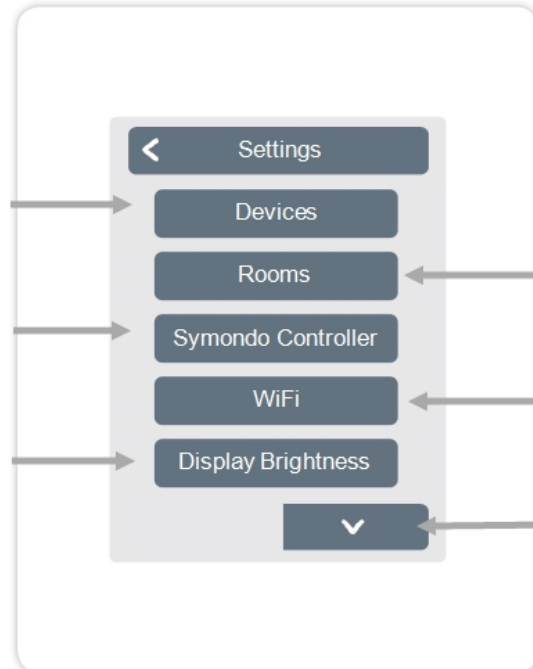

## Rooms

Add, manage and remove rooms and assign them to connected devices.

## WiFi

Set and manage WiFi functions.

## Interface Mode

Switch between full and restricted menu. Only the reference temperature can be set in the mode "Hide menu". To return to "full" mode, press and hold the upper-right corner of the display for 5 seconds.

## Room Sync.

If room synchronisation is activated, rooms set up on other Symondo Controller of the same network are also displayed on this Symondo Controller and vice versa.

# Devices



Clima systems have to be switched to 'heating' mode before another device can be added to a running system.



### Add Device

Starts the search for new available devices in the network.



### Device icon

Shows the type of connected device and its CAN ID.

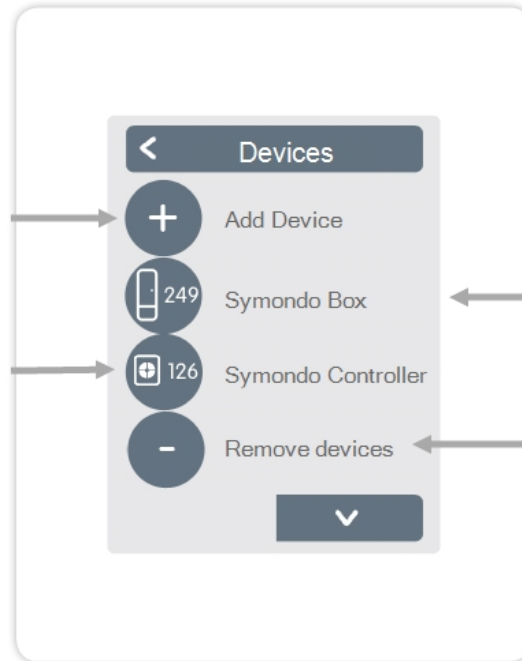

### Description

Displays the detected type of the device.



### Remove devices

Devices are removed from the network.

Add a Symondo Sensor WLAN / Symondo Sensor WLAN to your network.

For the commissioning of the Symondo Sensor WLAN / Symondo Sensor WLAN, please refer to the enclosed operating instructions.

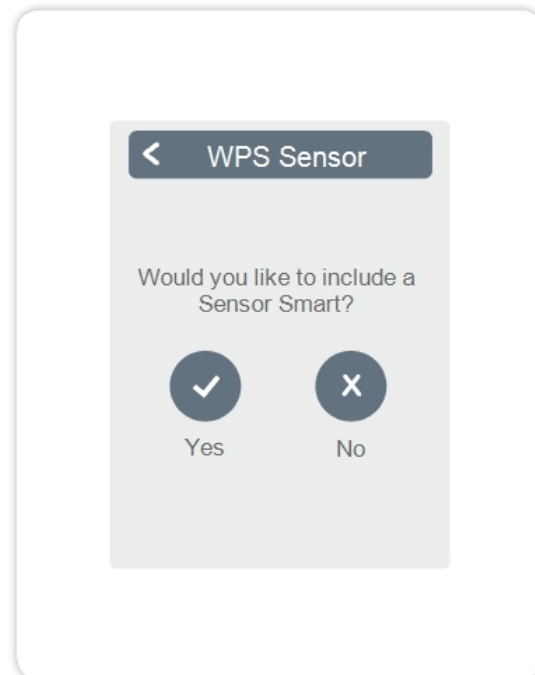

# Rooms

Overview > Operating mode > Menu > Expert > Settings > Rooms



**Add Room**  
Adding rooms.



**Room 2**  
Setting the location, sensors and actuators of the respective room.

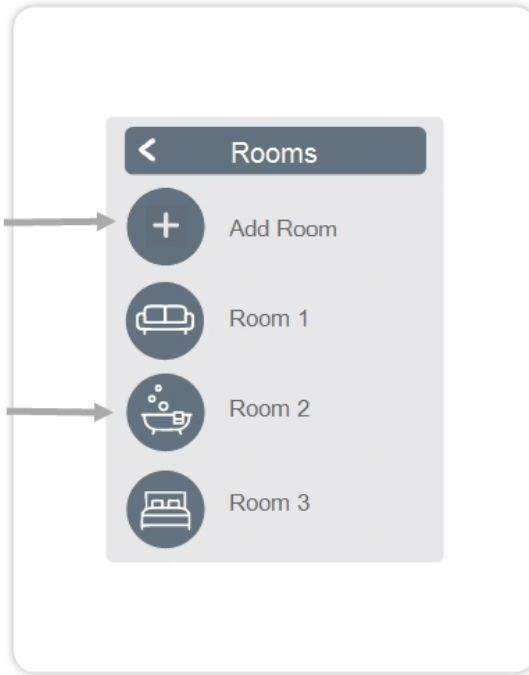

Overview > Operating mode > Menu > Expert > Settings > Room 2

**Location**  
Selection of room icon.

**Modulation Humidity**  
Sensors in the selected room.

**Remove Room**  
Remove the selected room.

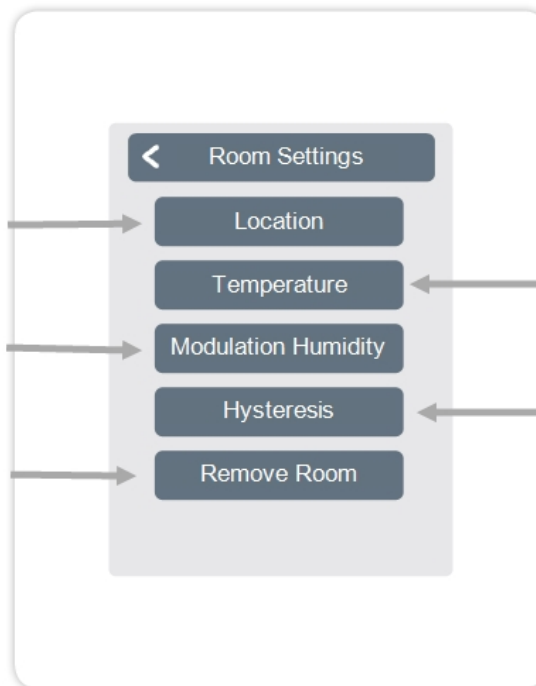

**Temperature**  
Sensors in the selected room.

**Hysteresis**  
Switch-off hysteresis for the room set-point temperature.

# Sensors

Overview > Operating mode > Menu > Expert > Settings > Rooms > Room 1 > Sensors > Temperature



**Icon**  
Sensor already selected.

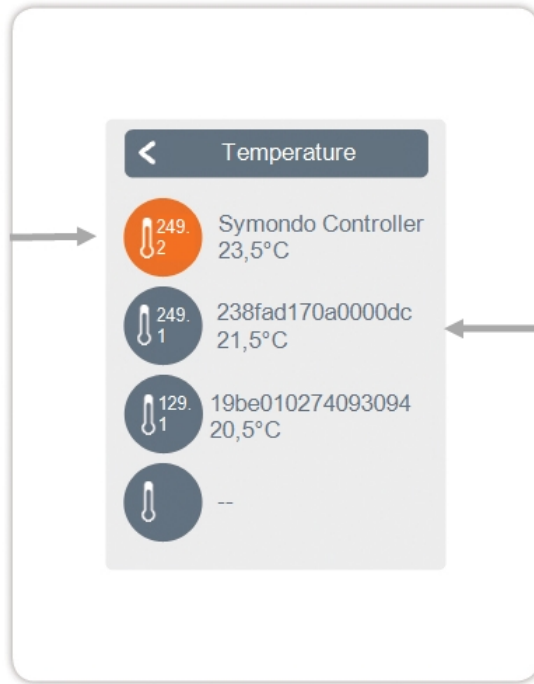

**Sensoricon with CAN ID + number**  
Temperature sensor selection in the selected room.

Overview > Operating mode > Menu > Expert > Settings > Rooms > Room 1 > Sensors > Humidity



**Sensoricon with CAN ID + number**  
Humidity sensor selection in the selected room.

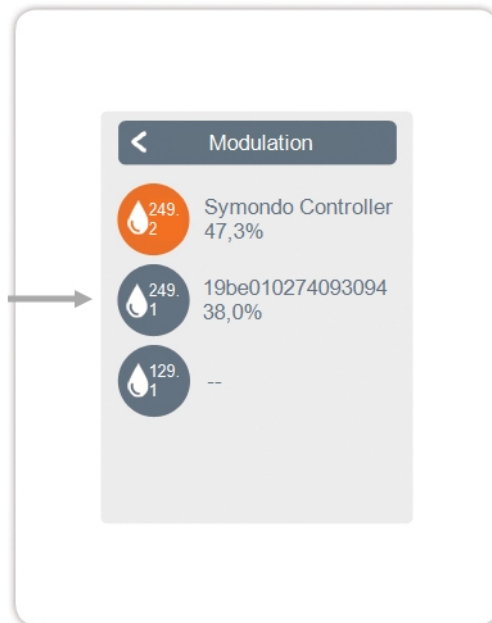

# Functions

Overview > Operating mode > Menu > Expert > Settings > Functions

Activate and set additional functions.

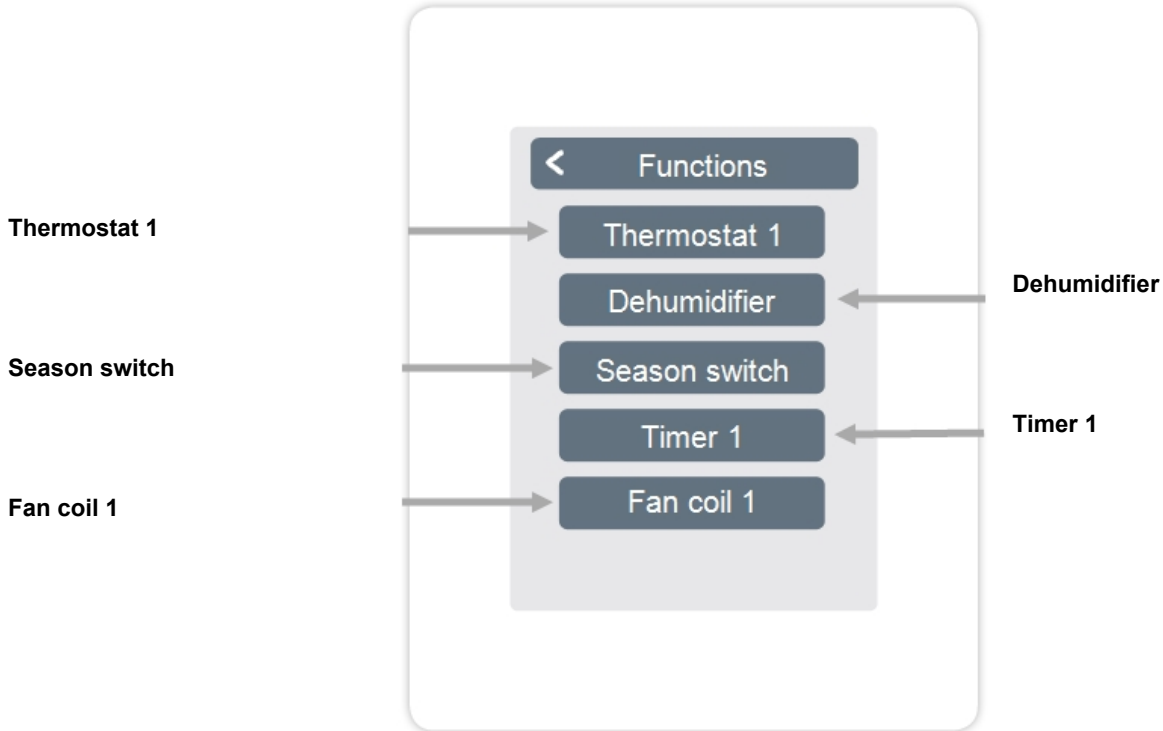

Overview > Operating mode > Menu > Expert > Settings > Functions > Thermostat 1

Switches the defined output to the set room / rooms depending on time and temperature.

## Output

Assign the output to be switched by the function. The other menu options become visible after assigning the output.

## Operating Mode

Set the operating mode of this thermostat function. Heating, cooling, or heating and cooling.

## Seizing Protection

If the seizing protection is activated (daily, weekly, off), the controller switches on the outputs one after the other at 12:00 noon for 5 seconds to prevent seizing of the connected device during longer inactivity.

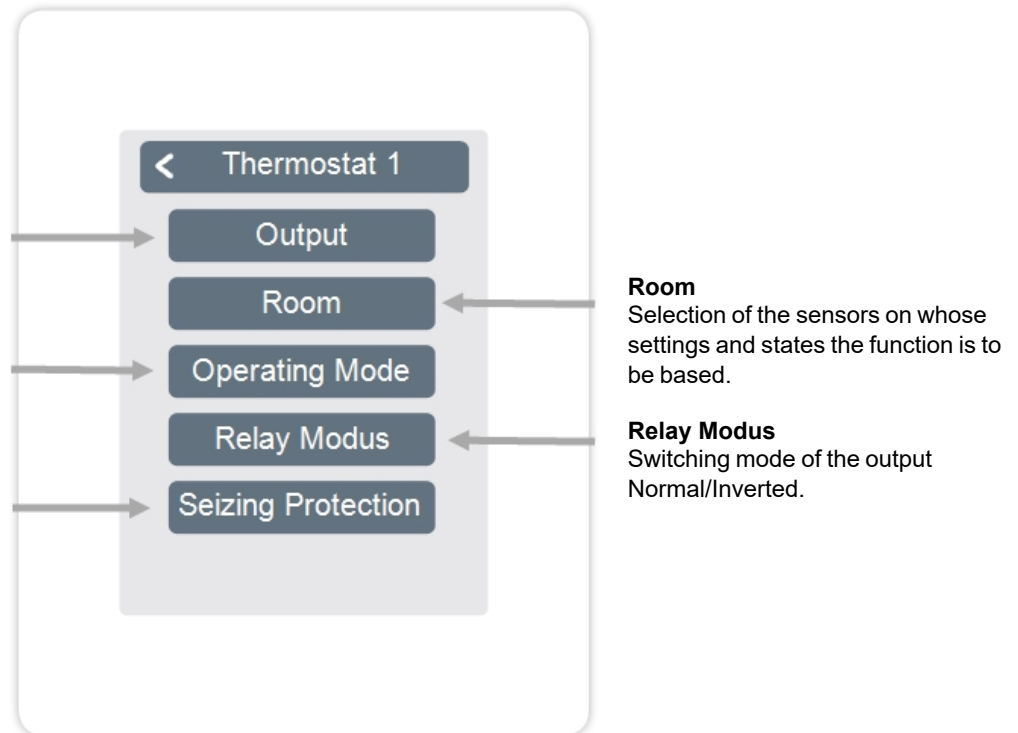

## Room

Selection of the sensors on whose settings and states the function is to be based.

## Relay Modus

Switching mode of the output Normal/Inverted.

The dehumidifier function switches the defined output depending on the set humidity in the set room(s).

**Output**

Assign the output to be switched by the function. The other menu options become visible after assigning the output.

**Modulation Humidity**

Set the limit value for the air humidity. If this is exceeded, the dehumidifier is switched on.

**Room**

Room selection for assigning the humidity of a room as the basis for switching the dehumidifier.

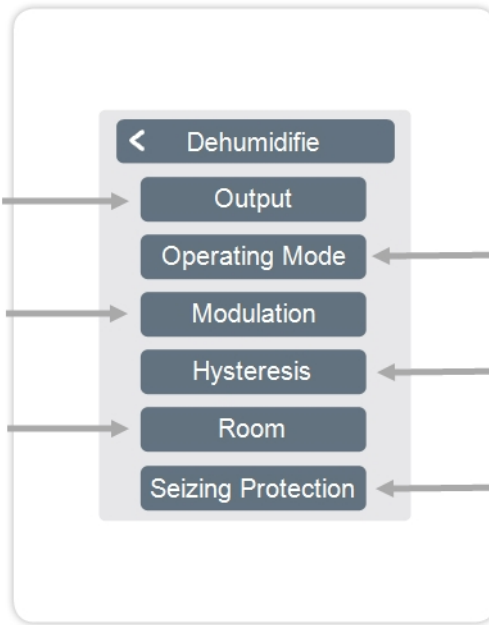

**Operating Mode**

Specify in which operating states of the heating and cooling system the dehumidifier is to be switched on.

**Hysteresis**

Define the switch-off hysteresis.

**Seizing Protection**

If the seizing protection is activated (daily, weekly, off), the controller switches on the outputs one after the other at 12:00 noon for 5 seconds to prevent seizing of the connected device during longer inactivity.

The seasonal switch changes the operating mode of the heat pump (compressor) between "heating" and "cooling". Therefore the heat pump (compressor) must be compatible with reversible operation.

**Output**

Assign the output to be switched by the function. The other menu options become visible after assigning the output.

**Seizing Protection**

If the seizing protection is activated (daily, weekly, off), the controller switches on the outputs one after the other at 12:00 noon for 5 seconds to prevent seizing of the connected device during longer inactivity.

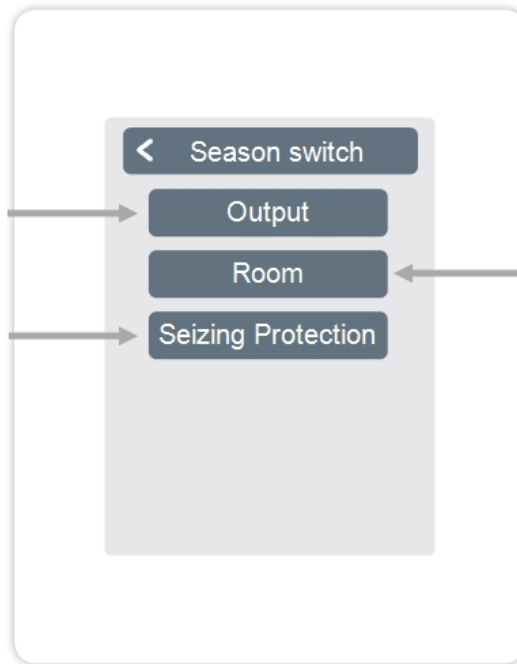

**Room**

Room selection to start the function. As soon as one of the assigned rooms switches from "heating" mode to "cooling" mode the season switch becomes active and the assigned relay is switched.

The function Timer 1-2 switches the defined output depending on the set times.

**Output**

Assign the output to be switched by the function.

**The other menu items become visible after the output has been assigned, as soon as at least one created room has a heat demand.**

**Seizing Protection**

If the seizing protection is activated (daily, weekly, off), the controller switches on the outputs one after the other at 12:00 noon for 5 seconds to prevent seizing of the connected device during longer inactivity.

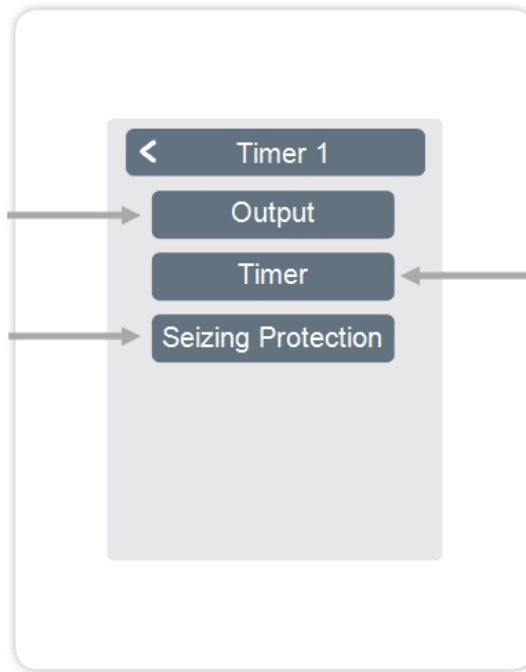

**Timer**

Set the times at which the outputs are to be switched.

The fan coil function controls convection heating and cooling via the 0-10V/PWM outputs .

**Output**

Assign the output to be switched by the function.

**The other menu options become visible after assigning the output.**

**Flow**

Assignment of the convector flow sensor in "Heating" mode.

**Room**

Selection of the sensors on whose settings and states the function is to be based.

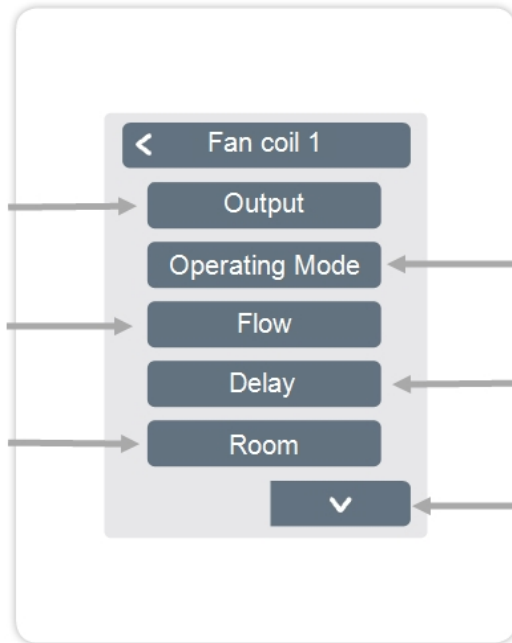

**Operating Mode**

Set the operating mode of this convector function. Heating, cooling, or heating and cooling.

**Delay**

Delays the switching on of the fan coil so that it does not push against closed valves.

**Modulation Humidity**

Set the limit value for the air humidity. If this is exceeded, the dehumidifier is switched on.

**Hysteresis**

Define the switch-off hysteresis.

**Modulation**

Modulation of the output for power control

**Signal type**

Selection of the control:  
 0-10V = voltage signal  
 PWM = square wave signal

**Relay Modus**

Switching mode of the output  
 Normal/Inverted.

**Off Signal**

Signal to switch off the target device

**On Signal**

Signal to switch on the target device at minimum power

**Max Signal**

Signal to set target device to maximum power

**Seizing Protection**

If the seizing protection is activated (daily, weekly, off), the controller switches on the outputs one after the other at 12:00 noon for 5 seconds to prevent seizing of the connected device during longer inactivity.

### Activate WiFi

Activate WiFi function.

### Select Network

Scan for available networks and select the network.

### SSID

Manually enter the WLAN name.

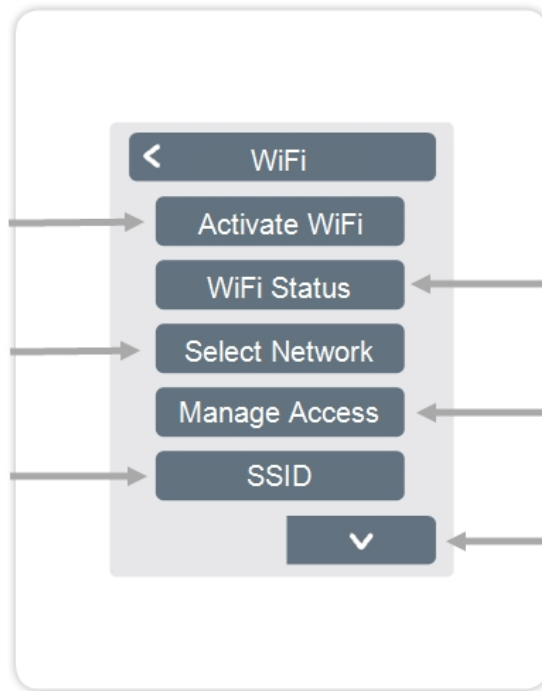

### WiFi status

Information about WiFi status and device address (which is required to connect to the Symondo App).

### Manage Access

Allow up to 5 users to access the unit via Symondo App by entering their e-mail addresses.

### WiFi

Entering the WiFi password

### Activate DHCP

If auto-configuration is enabled, the device searches the network for a DHCP server that assigns it an IP address, subnet mask, gateway IP and DNS server IP. If you deactivate the auto configuration (DHCP), you will have to make the required network settings manually!

See the following points:

### IP address

Enter the Symondo Controller IP address.

### Network mask

Set the network mask.

### Gateway

Set the gateway address.

### DNS/ DNS 2

Set the DNS address.

### WPS

Connecting the Symondo Controller WLAN to a WPS-enabled router.

### Access Point

Settings for routing and the WPS Repeater.

### WiFi Sensor

Settings for the LED display and the transmission interval.

## Access Point

Overview > Operating Mode > Menu > Expert > Settings > WiFi > Access Point

### Routing Mode

The automatic routing independently selects between a direct connection of WiFi devices with the access point of the Symondo Controller and indirect connection via the WLAN router. As not all routers support this function, the setting "No" is recommended in case of problems in WiFi communication. In this case, all communication runs via the WLAN router. If there is no router, the communication runs via the access point of the Symondo Controller.

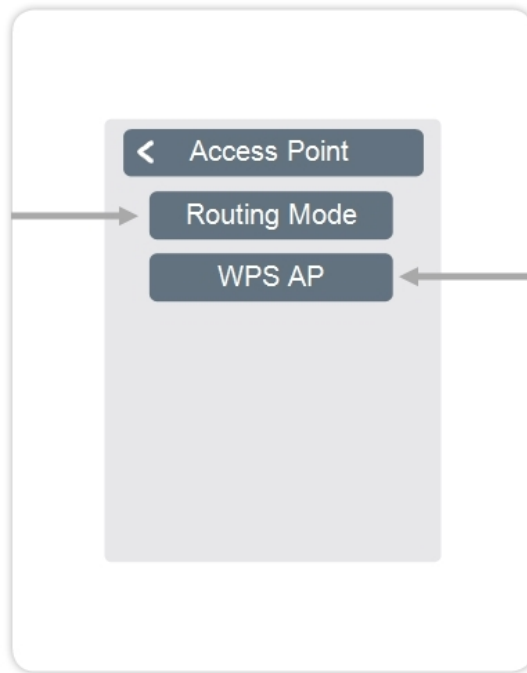

### WPS AP

Add a WPS-enabled repeater to increase the range.

## WiFi Sensor

Overview > Operating Mode > Menu > Expert > Settings > WiFi > WiFi Sensor

### LED-Mode

LED behaviour settings. Sending of sensor values successful = LED lights up green Sending of sensor values failed = LED flashes red In "Still" mode, the LED only flashes red if the sending of sensor values has failed 3 times in succession.

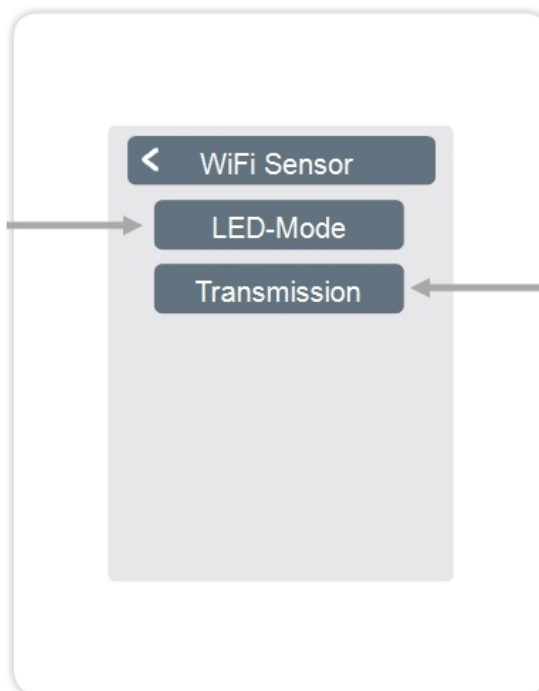

### Transmission interval

Setting of the time between two transmissions in minutes.



A short transmission interval can lead to problems with the WLAN connection with some routers.

### Message Log

Displays the error memory.

### CAN Bus Status

Display the CAN bus status.

### System Status

Enables an update of all connected components.

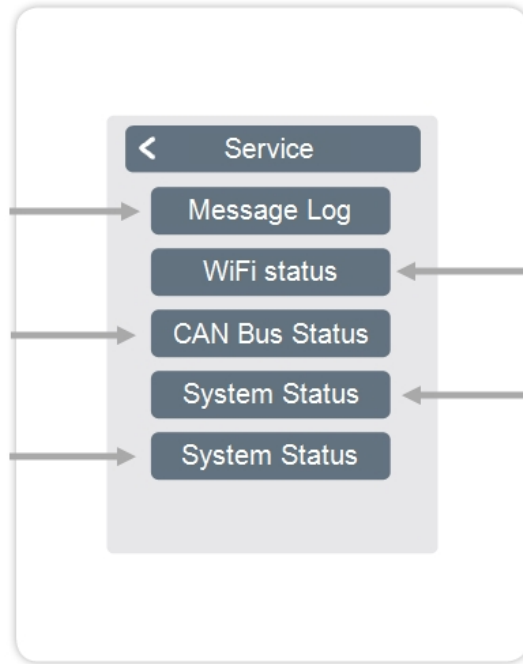

### WiFi status





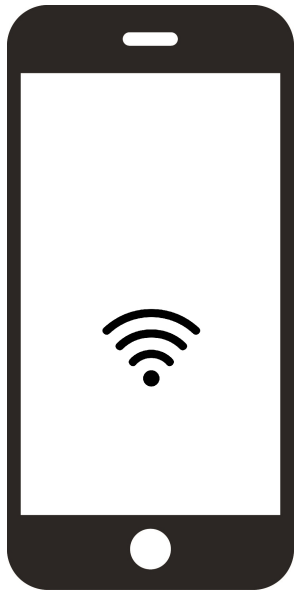

Displays the WiFi status.

### System Status

Displays the system status.

## Symondo Controller WLAN and Symondo App Configuration



-  1. Download Symondo App app to your mobile device. Currently available on Google Play (Android) and Apple App Store (iOS).
-  2. Start app and create account.
-  3. Click activation link in your e-mail inbox.
-  4. Connect Symondo Controller WLAN with the WLAN network:  
Expert → Settings → WiFi → Choose Network
-  5. Set the selected e-mail address to the access list in the Symondo Controller WLAN : Expert → Settings → WiFi → "Access Control
-  6. Log in to app with e-mail and password
-  7. Enter the device address in the Symondo App. The device address can be found in the device:  
Expert → Settings → WiFi → WiFi Status

## Support

Event	Support
The display does not show anything.	Is the device connected to the power supply? Is the mains connection voltage? Has the electrical connection been made as described in the user manual?
The heating/cooling circuit does not respond to my Symondo Controller WLAN.	Is Symondo Controller WLAN assigned to the heating circuit in the controller menu? Is the CAN bus wiring between controller and Symondo Controller WLAN correct?
The CAN bus connection is incorrect.	Is the CAN bus connection properly installed and have all devices been wired <u>in line</u> (no star!)? Are end resistors set on the first and last device for termination of the bus?
No additional function can be assigned to a relay/V output under "Functions".	Is the selected function already assigned to another output? Is the output already assigned to another function?

## Notes

## **Final Declaration**

Although these instructions have been created with the greatest possible care, the possibility of incorrect or incomplete information cannot be excluded. Subject as a basic principle to errors and technical changes.

**Date and time of installation:**

**Name of installation company:**

**Space for notes:**

MULTIBETON Produktions- und Vertriebsgesellschaft  
für Heizungs- und Energietechnik mbH

Heuserweg 23  
53842 Troisdorf-Spich

Telefon: +49 22 41 25200-0  
Telefax: +49 22 41 25200-99

info@multibeton.de  
www.multibeton.de

Version: 19.04.2023