

Data Sheet

Danfoss *Icon*™ App module

Description



Danfoss *Icon*™ App Module is used to enable wifi and APP control on the Danfoss *Icon*™ 24V Master Controller.

The App Module is connected using a shielded patch cable (2 m cable included in box).

Once connected to a smart phone or tablet the system can be shared across devices in the household.

App Module will enable:

- Remote access
- Scheduling
- Away, comfort and holiday mode
- System alarms on your device e.g. low battery on thermostat

Ordering

Product	Code number
Danfoss <i>Icon</i> ™ App Module	088U1101

Technical data

Purpose of control	Wi-Fi transmitting and receiving device, incl. Bluetooth
Ambient temperature range, continuous use	0 °C to +40 °C
Frequency	2,4 GHz
Encapsulation (IP Class)	IP 20
Conformity declared acc. to following directives	RED, RoHS, WEEE
Protection class Radio	Class III
Supply voltage	5 VDC
Temperature for the ball pressure test	75 °C
Control pollution degree	Degree 2, normal household environment
Software class	Class A
Rated impulse voltage	4 kV
Operating time	Permanently connected
Temperature range, storage and transportation	-20 °C to +65 °C
Disposal instructions	The product must be disposed as electronic waste.

Drawings

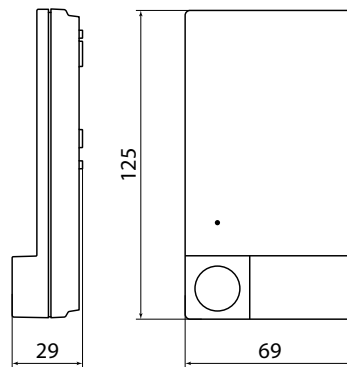

Danfoss *Icon*™ App Module 088U1101

Danfoss A/S

Heating Segment • heating.danfoss.com • +45 7488 2222 • E-Mail: heating@danfoss.com

Danfoss can accept no responsibility for possible errors in catalogues, brochures and other printed material. Danfoss reserves the right to alter its products without notice. This also applies to products already on order provided that such alterations can be made without subsequential changes being necessary in specifications already agreed. All trademarks in this material are property of the respective companies. Danfoss and all Danfoss logotypes are trademarks of Danfoss A/S. All rights reserved.

Installation Guide

App Module

for Danfoss *Icon*™ Master



Placement

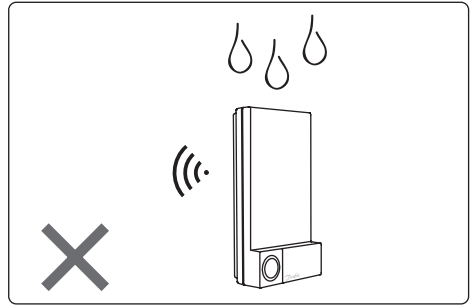
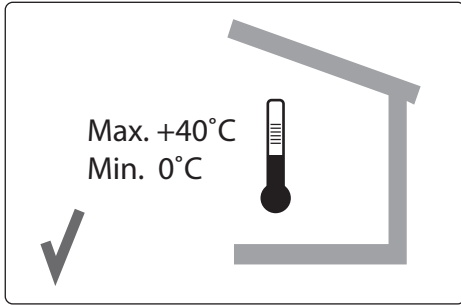

Installation

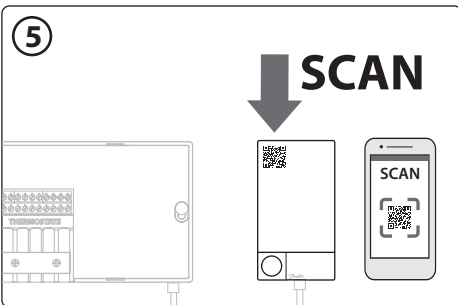
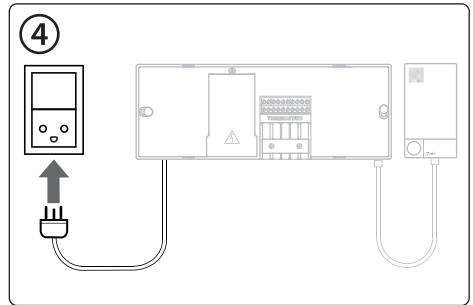
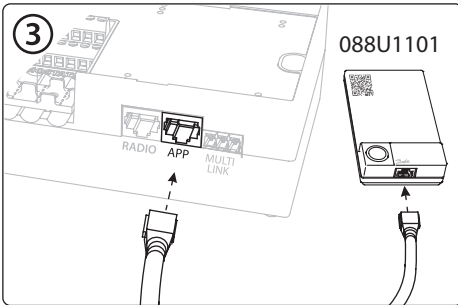
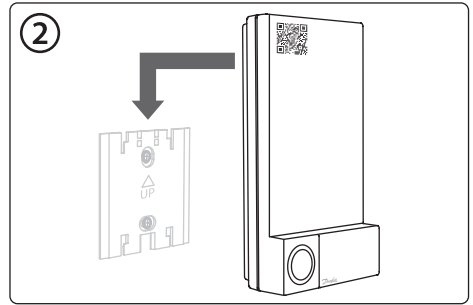
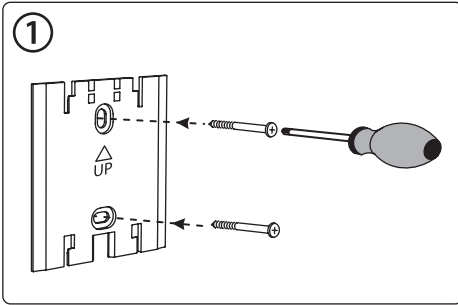

Declaration of Conformity

GB	Hereby, Danfoss A/S declares that the radio equipment type App Module is in compliance with Directive 2014/53/EU. The full text of the EU declaration of conformity is available at the following internet address: heating.danfoss.com
DE	Hiermit erklärt Danfoss A/S , dass der Funkanlagentyp App Module der Richtlinie 2014/53/EU entspricht. Der vollständige Text der EU-Konformitätserklärung ist unter der folgenden Internetadresse verfügbar: heating.danfoss.com
FR	Le soussigné, Danfoss A/S , déclare que l'équipement radioélectrique du type App Module est conforme à la directive 2014/53/UE. Le texte complet de la déclaration UE de conformité est disponible à l'adresse internet suivante: heating.danfoss.com
IT	Il fabbricante, Danfoss A/S , dichiara che il tipo di apparecchiatura radio App Module è conforme alla direttiva 2014/53/UE. Il testo completo della dichiarazione di conformità UE è disponibile al seguente indirizzo Internet: heating.danfoss.com
NL	Hierbij verklaar ik, Danfoss A/S , dat het type radioapparatuur App Module conform is met Richtlijn 2014/53/EU. De volledige tekst van de EU-conformiteitsverklaring kan worden geraadpleegd op het volgende internetadres: heating.danfoss.com
DK	Hermed erklærer Danfoss A/S , at radioudstyrstypen type App Module er i overensstemmelse med direktiv 2014/53/EU. EU-overensstemmelseserklæringens fulde tekst kan findes på følgende internetadresse: heating.danfoss.com
SE	Härmed försäkrar Danfoss A/S att denna typ av radioutrustning App Module överensstämmer med direktiv 2014/53/EU. Den fullständiga texten till EU-försäkran om överensstämmelse finns på följande webbadress: heating.danfoss.com
FI	Danfoss A/S vakuuttaa, että radiolaitetyyppi App Module on direktiivin 2014/53/EU mukainen. EU-vaatimustenmukaisuusvakuutuksen täysimittainen teksti on saatavilla seuraavassa internetosoitteessa: heating.danfoss.com
LT	Aš, Danfoss A/S , patvirtinu, kad radijo įrenginių tipas App Module atitinka Direktyvą 2014/53/ES. Visas ES atitikties deklaracijos tekstas prieinamas šiuo interneto adresu: heating.danfoss.com
PL	Danfoss A/S niniejszym oświadcza, że typ urządzenia radiowego App Module jest zgodny z dyrektywą 2014/53/UE. Pełny tekst deklaracji zgodności UE jest dostępny pod następującym adresem internetowym: heating.danfoss.com

Danfoss A/S

FEC-H • Ulvehavevej 61 • DK-7100 Vejle • Denmark

Phone: +45 7488 8500 • Fax: +45 7488 8501 • heating@danfoss.com • www.floorheating.danfoss.com

Danfoss can accept no responsibility for possible errors in catalogues, brochures and other printed material. Danfoss reserves the right to alter its products without notice. This also applies to products already on order provided that such alterations can be made without consequential changes being necessary in specifications already agreed. All trademarks in this material are property of the respective companies. Danfoss and the Danfoss logotype are trademarks of Danfoss A/S. All rights reserved.