

Data Sheet

Danfoss *Icon*™ Repeater

Description



Danfoss *Icon*™ Repeater is used to extend the range between thermostats and master controller or to troubleshoot in systems with objects impeding the signal. The repeater can be plugged directly into a 230 V power outlet.

Application

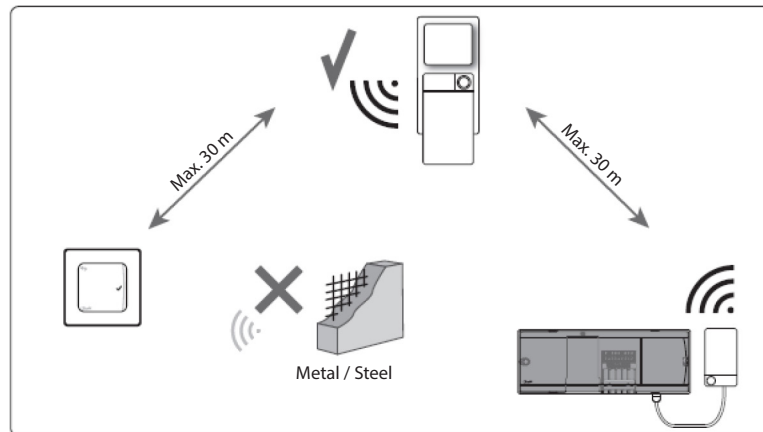

Ordering

Product	Code number
Danfoss <i>Icon</i> ™ Repeater	088U1102

Tecnical data

Purpose of control	Extending the range of the radio signal.
Ambient temperature range, continious use	0 °C to +40 °C
Frequency	868,4-869,85 MHz
Encapsulation (IP Class)	IP 20
Conformity declared acc. to following directives	RED, RoHS, WEEE
Protection class Radio	Class III
Supply voltage	230 VAC 50 Hz
Temperature for the ball pressure test	75 °C
Control polution degree	Degree 2, normal household environment
Software class	Class A
Rated impulse voltage	4 kV
Operating time	Permanently connected
Temperature range, storage and transportation	-20 °C to +65 °C
Dispossal instructions	The product must be disposed as electronic waste.

Drawings

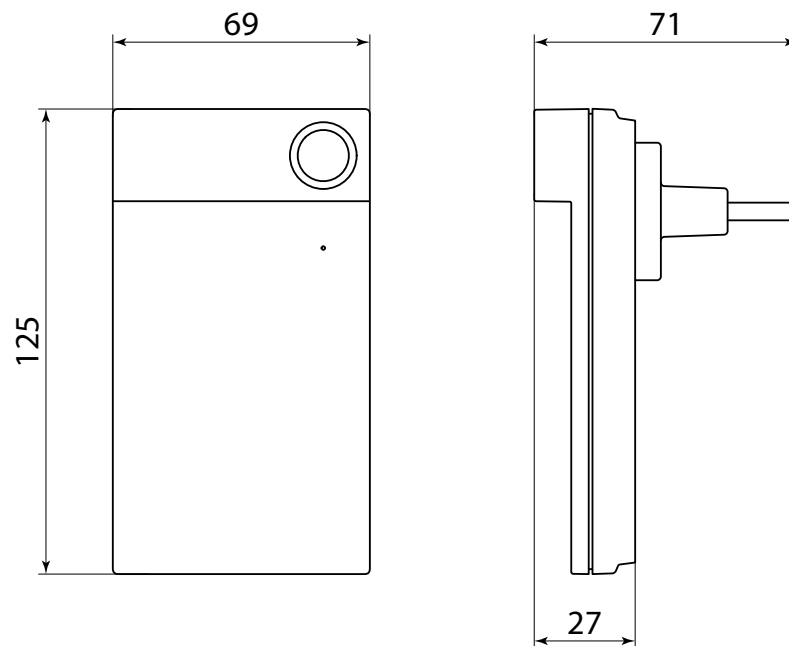

Danfoss *Icon*™ Repeater 088U1102

Danfoss A/S

Heating Segment • heating.danfoss.com • +45 7488 2222 • E-Mail: heating@danfoss.com

Danfoss can accept no responsibility for possible errors in catalogues, brochures and other printed material. Danfoss reserves the right to alter its products without notice. This also applies to products already on order provided that such alterations can be made without subsequential changes being necessary in specifications already agreed. All trademarks in this material are property of the respective companies. Danfoss and all Danfoss logotypes are trademarks of Danfoss A/S. All rights reserved.

Installation Guide

Repeater

for Danfoss *Icon*™ Master

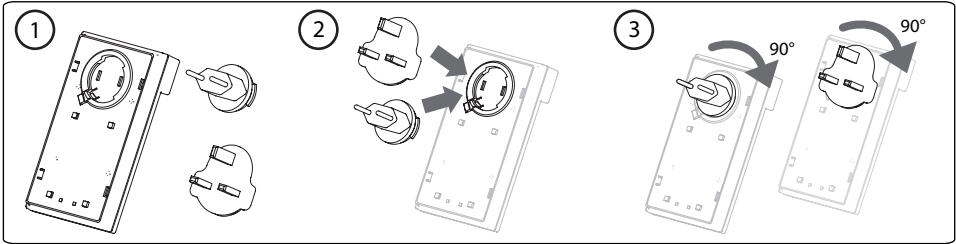

Placement

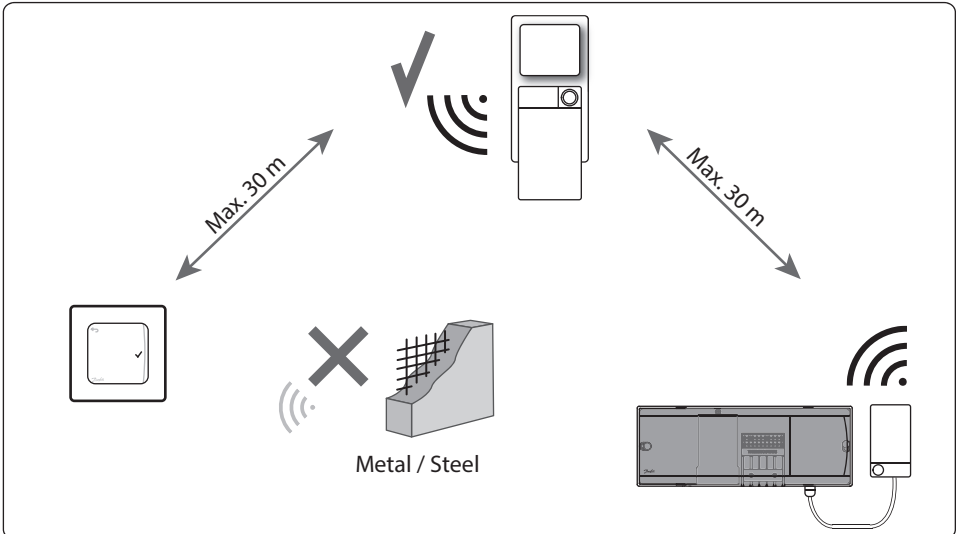
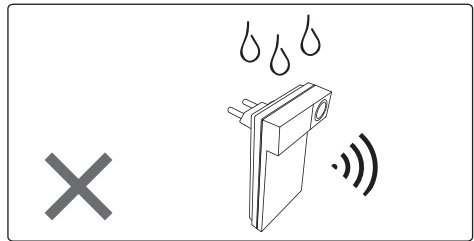
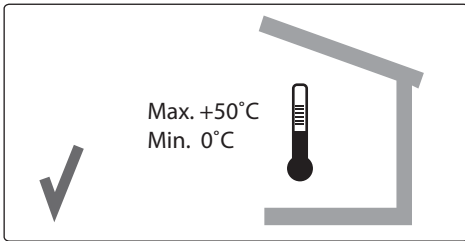

Installation

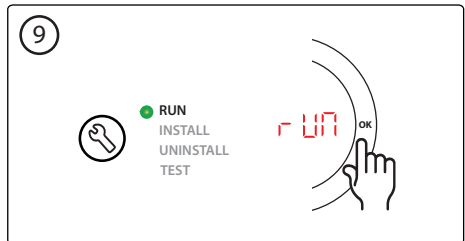
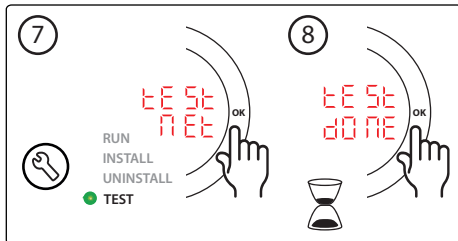
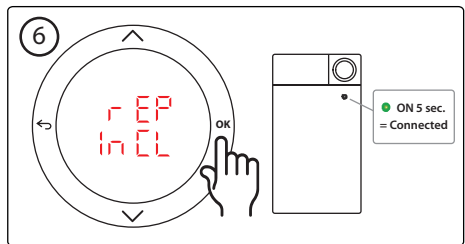
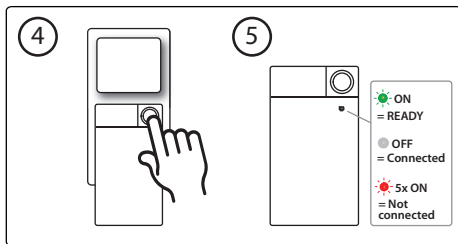
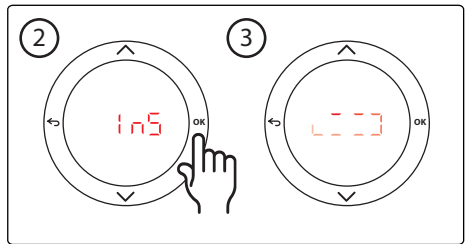
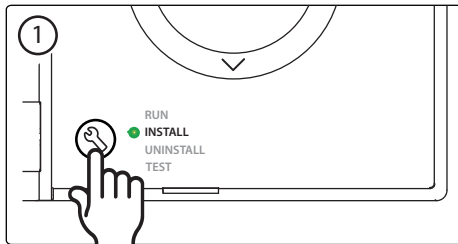

Declaration of Conformity

GB	Hereby, Danfoss A/S declares that the radio equipment type Radio Module is in compliance with Directive 2014/53/EU. The full text of the EU declaration of conformity is available at the following internet address: heating.danfoss.com
DE	Hiermit erklärt Danfoss A/S , dass der Funkanlagentyp Radio Module der Richtlinie 2014/53/EU entspricht. Der vollständige Text der EU-Konformitätserklärung ist unter der folgenden Internet-Adresse verfügbar: heating.danfoss.com
FR	Le soussigné, Danfoss A/S , déclare que l'équipement radioélectrique du type Radio Module est conforme à la directive 2014/53/UE. Le texte complet de la déclaration UE de conformité est disponible à l'adresse internet suivante: heating.danfoss.com
IT	Il fabbricante, Danfoss A/S , dichiara che il tipo di apparecchiatura radio Radio Module è conforme alla direttiva 2014/53/UE. Il testo completo della dichiarazione di conformità UE è disponibile al seguente indirizzo Internet: heating.danfoss.com
NL	Hierbij verklaar ik, Danfoss A/S , dat het type radioapparatuur Radio Module conform is met Richtlijn 2014/53/EU. De volledige tekst van de EU-conformiteitsverklaring kan worden geraadpleegd op het volgende internetadres: heating.danfoss.com
DK	Hermed erklærer Danfoss A/S , at radioudstyrstypen type Radio Module er i overensstemmelse med direktiv 2014/53/EU. EU-overensstemmelseserklæringens fulde tekst kan findes på følgende internetadresse: heating.danfoss.com
SE	Härmed försäkrar Danfoss A/S att denna typ av radioutrustning Radio Module överensstämmer med direktiv 2014/53/EU. Den fullständiga texten till EU-försäkran om överensstämmelse finns på följande webbadress: heating.danfoss.com
FI	Danfoss A/S vakuuttaa, että radiolaitetyyppi Radio Module on direktiivin 2014/53/EU mukainen. EU-vaatimustenmukaisuusvakuutuksen täysimittainen teksti on saatavilla seuraavassa internetosoitteessa: heating.danfoss.com
LT	Aš, Danfoss A/S , patvirtinu, kad radijo įrenginių tipas Radio Module atitinka Direktyvą 2014/53/ES. Visas ES atitikties deklaracijos tekstas prieinamas šiuo interneto adresu: heating.danfoss.com
PL	Danfoss A/S niniejszym oświadcza, że typ urządzenia radiowego Radio Module jest zgodny z dyrektywą 2014/53/UE. Pełny tekst deklaracji zgodności UE jest dostępny pod następującym adresem internetowym: heating.danfoss.com

ENGINEERING
TOMORROW



14201.000.00 Manual Ins RU Danfoss

Danfoss A/S
Heating Segment • heating.danfoss.com • +45 7488 2222 • E-Mail: heating@danfoss.com

Danfoss can accept no responsibility for possible errors in catalogues, brochures and other printed material. Danfoss reserves the right to alter its products without notice. This also applies to products already on order provided that such alterations can be made without subsequential changes being necessary in specifications already agreed. All trademarks in this material are property of the respective companies. Danfoss and all Danfoss logotypes are trademarks of Danfoss A/S. All rights reserved.